

LEGEND

PROPOSED

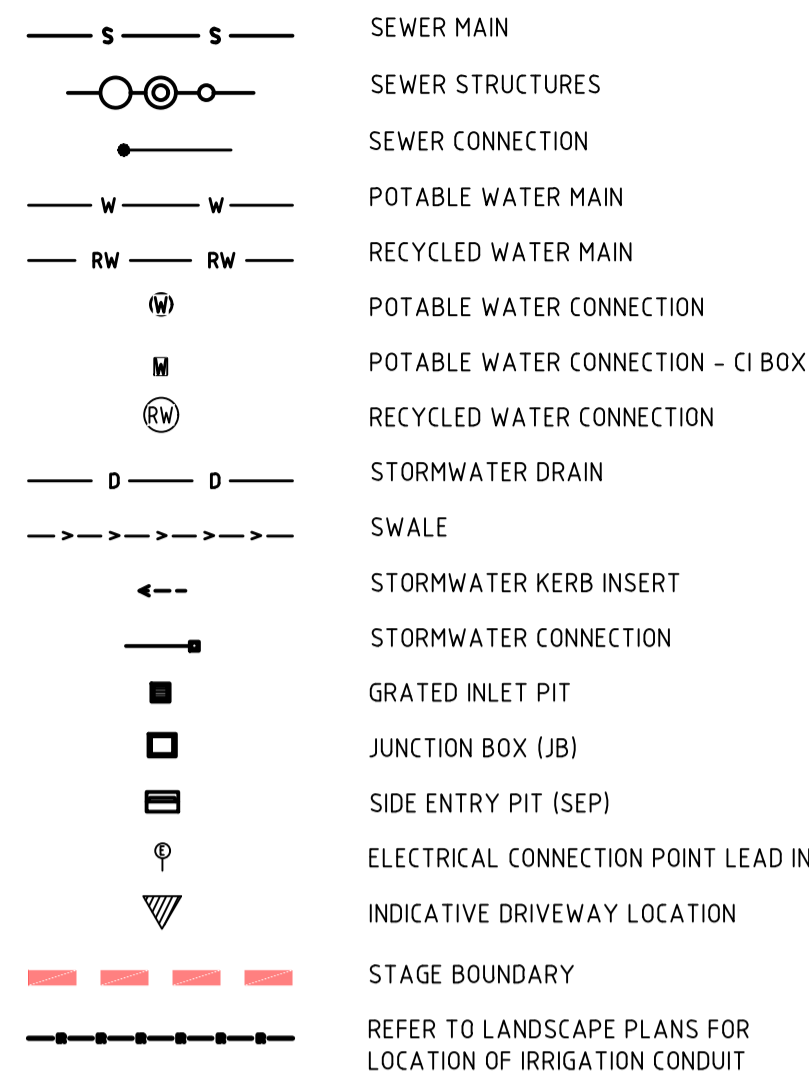

EXISTING

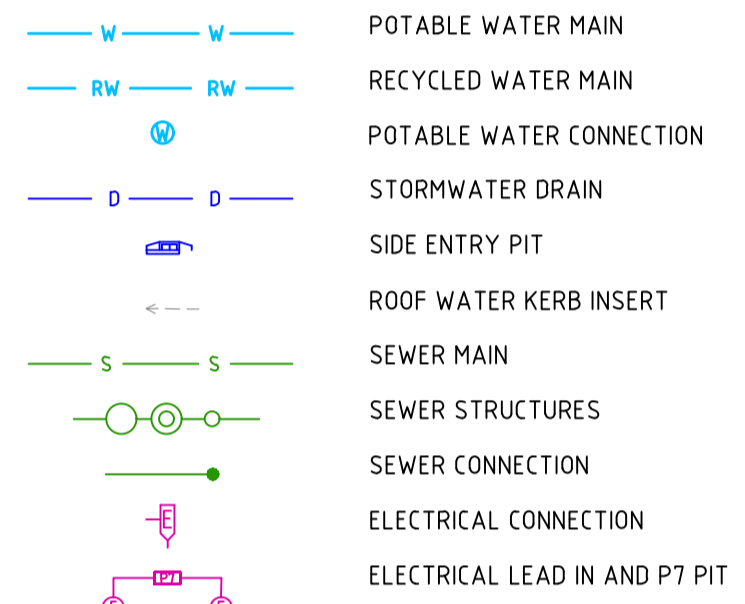

FUTURE

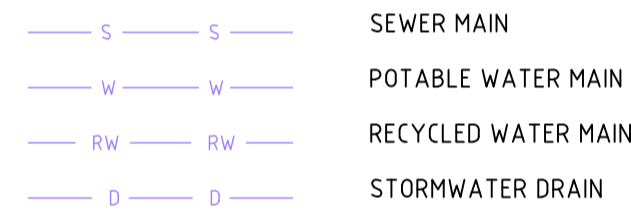

EXISTING SERVICES:

1. THE SERVICES INFORMATION INDICATED ON THIS DRAWING IS BASED ON FIELD OBSERVATIONS AND DETAILS PROVIDED BY SERVICE AUTHORITIES. GREENHILL ENGINEERS DOES NOT GUARANTEE THAT THE DETAIL OR EXTENT OF SERVICES INFORMATION SHOWN IS ACCURATE OR COMPLETE. THE CONTRACTOR SHALL CONFIRM LOCATION AND DEPTH OF ALL EXISTING SERVICES PRIOR TO COMMENCEMENT OF CONSTRUCTION. LANSER COMMUNITIES, GREENHILL ENGINEERS PTY LTD, CONSULTANTS, SERVANTS OR AGENTS SHALL NOT BE LIABLE FOR ANY LOSS OR DAMAGE CAUSED OR OCCASIONED BY THE USE OF THIS SERVICES INFORMATION.
2. THE CONTRACTOR SHALL CONFIRM THE LOCATION OF ALL EXISTING SERVICES PRIOR TO COMMENCEMENT OF CONSTRUCTION. THE CONTRACTOR SHALL MAKE ARRANGEMENTS WITH THE RELEVANT AUTHORITIES TO RELOCATE SERVICES AS NECESSARY TO RESOLVE CLASHES IN CONSULTATION WITH THE SUPERINTENDENT. ANY REPAIRS TO DAMAGED SERVICES WILL BE COMPLETED AT THE CONTRACTORS COST.
3. SERVICES SHOWN ON THESE SHEETS ARE FOR COORDINATION PURPOSES ONLY. FOR DETAILS OF EACH SERVICE REFER TO THE APPROVAL DRAWINGS FOR THAT SERVICE.

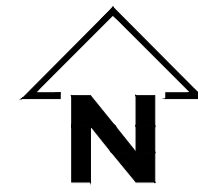

FOR CONTINUATION, REFER TO THE RIGHT

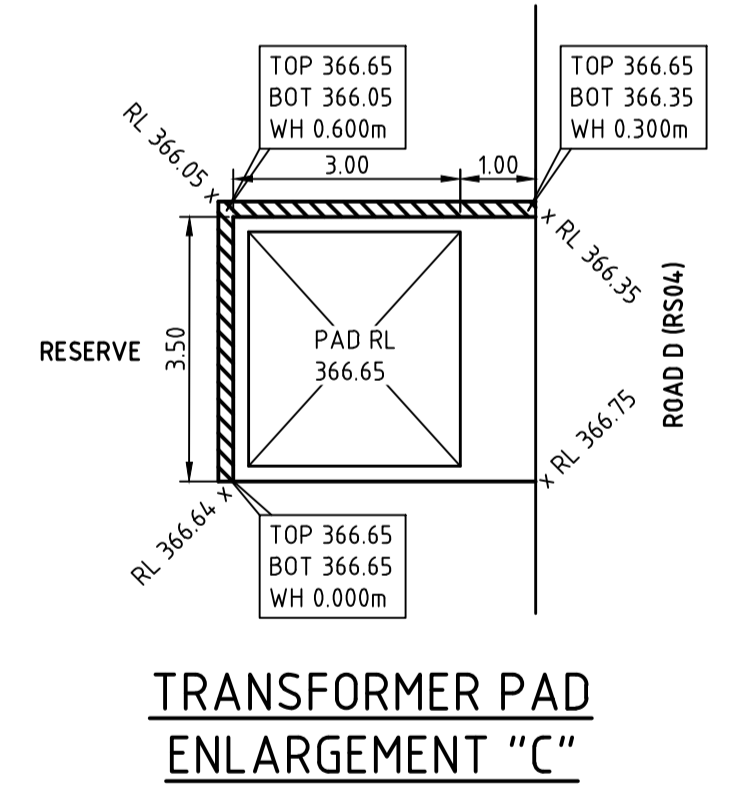
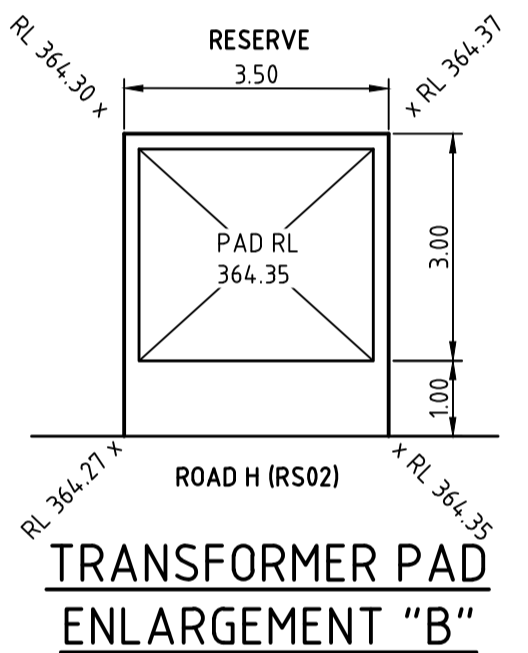
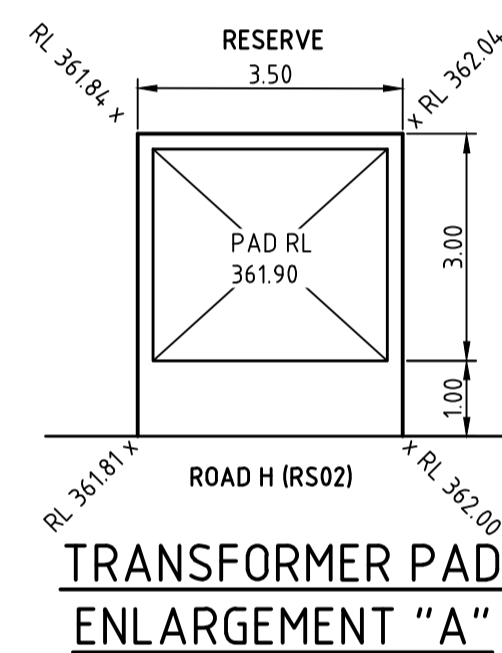
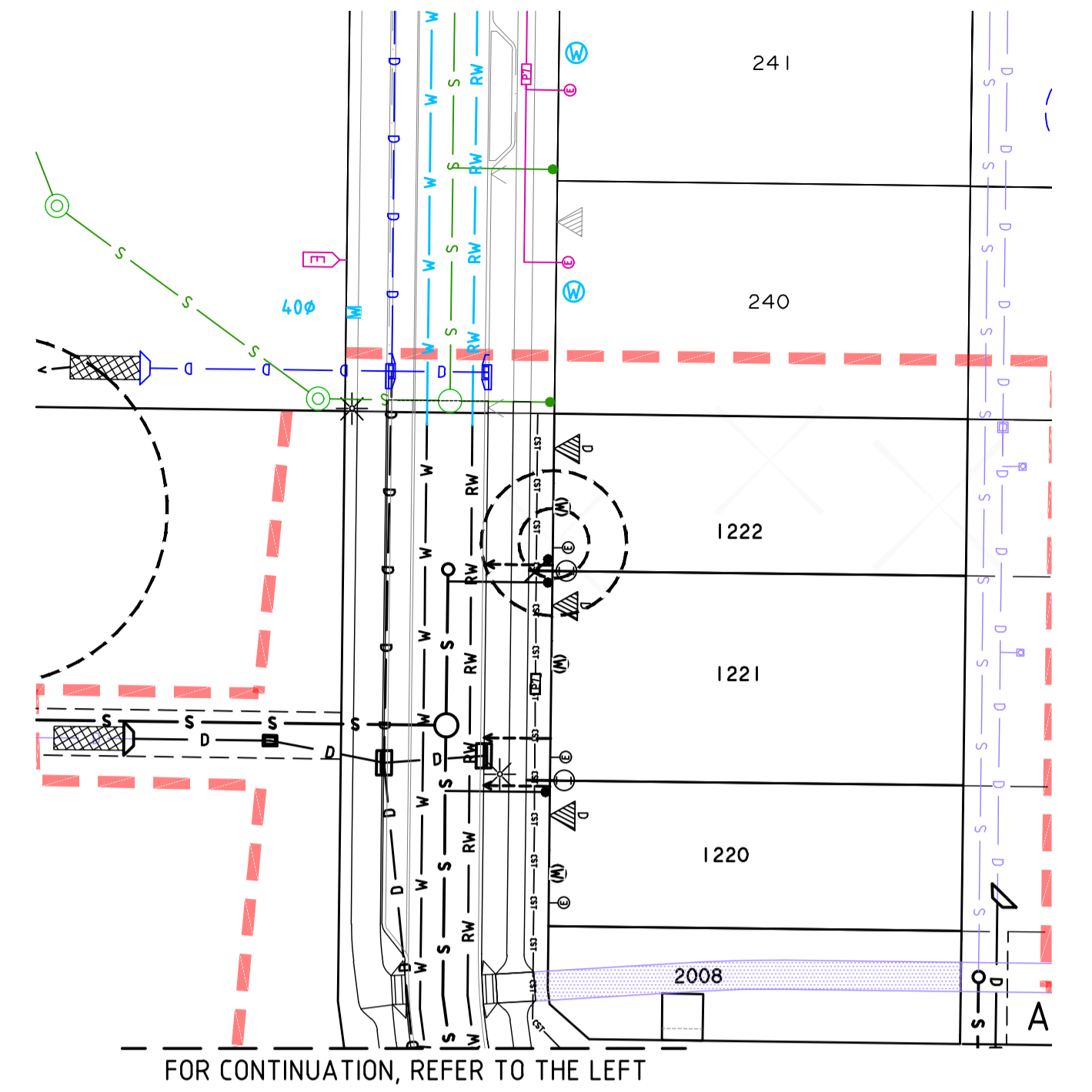
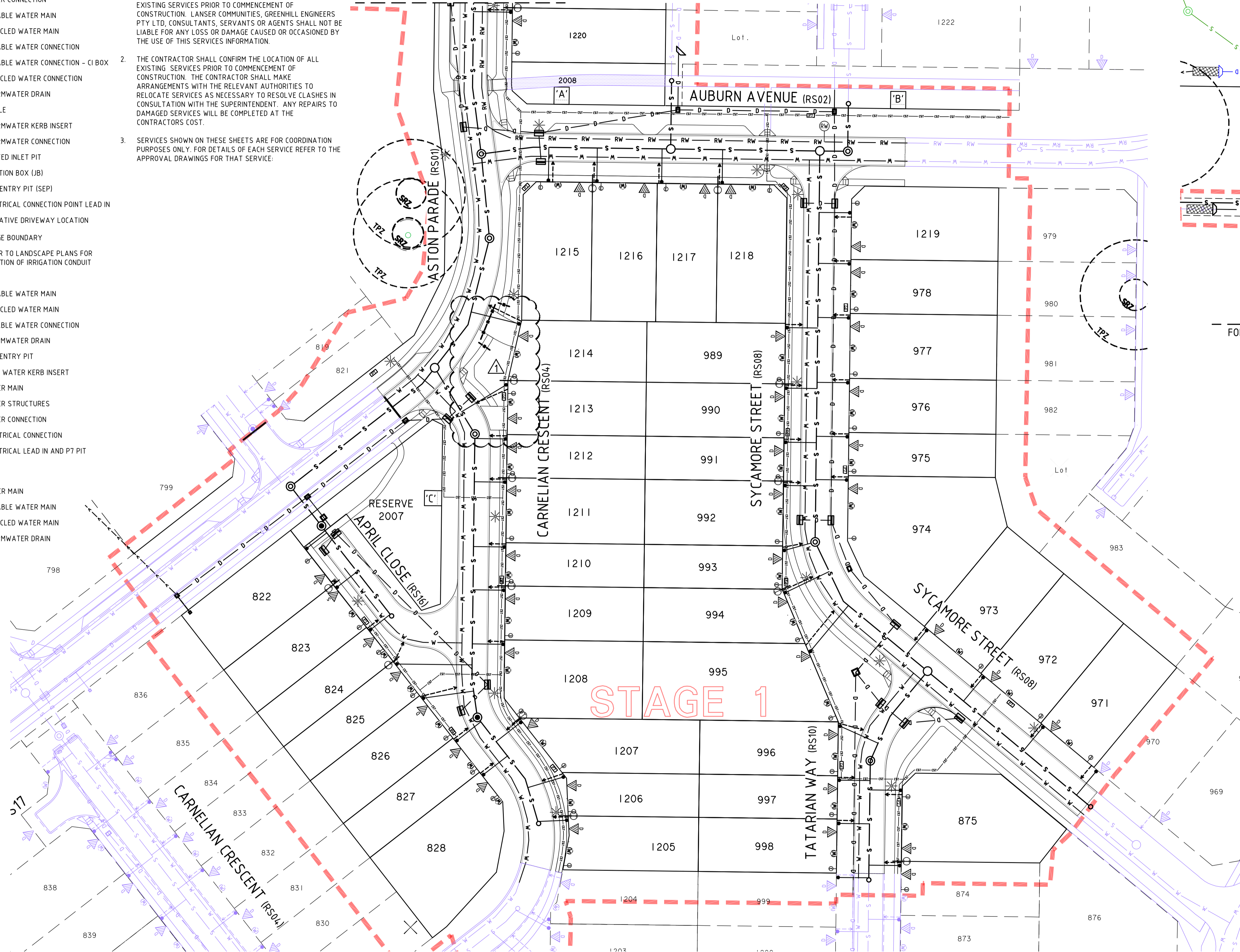

TRANSFORMER PAD NOTES:

- * ELECTRICAL TRANSFORMER EASEMENTS SUBJECT TO STRUCTURAL DESIGN OF RETAINING WALLS. SLEEPER RETAINING WALL INCLUDING AGG PIPE BEHIND WALL TO BE CONSTRUCTED TOTALLY WITHIN EASEMENT.

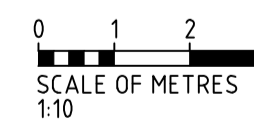

FOR CONSTRUCTION

REVISION	DATE	DESCRIPTION	DESIGN	DRAWN	APPROVED
1	02.03.23	REVISIONS AS CLOUDED	MS	FDC	
0	11.10.22	ISSUED FOR CONSTRUCTION	MS	FDC	AF
E	09.09.22	FOR APPROVAL	MS	FDC	
D	17.08.22	FOR APPROVAL	MS	FDC	
C	24.06.22	FOR TENDER	MS	FDC	
B	17.06.22	UPDATED LAYOUT	MS	FDC	
A	06.05.22	FOR TENDER	MS	FDC	

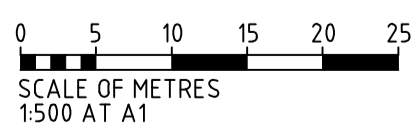

DESIGN	MS	DESIGN CHECK	DM
DRAWN	FDC	DRAFTING CHECK	AF
APPROVED	AF	DATE	11.10.22

CAD FILE: 21-2832-118

A1 THIS DRAWING REMAINS THE PROPERTY OF GREENHILL ENGINEERS PTY LTD AND MAY NOT BE COPIED IN ANY WAY WITHOUT PRIOR APPROVAL FROM THIS COMPANY.
© GREENHILL ENGINEERS PTY LTD

GREENHILL
Level 1, 178 Fullarton Road
Dulwich, SA 5065
T: 08 8406 1300

ABN 39 061 222 964

LANSER DEVELOPMENTS NO 1 PTY LTD
PACCH STAGE 1
MOUNT BARKER
COMBINED SERVICES PLAN

DRAWING NUMBER 21-2832-118	REVISION 1
--------------------------------------	----------------------